

Norges miljø- og
biovitenskapelige
universitet

Moving from FAIR data principles to XAIR

Martin Thomas Horsch
Norwegian University of Life Sciences

CAPE-OPEN Annual Meeting
8th October 2024, Berlin

Fakultet for realfag og teknologi

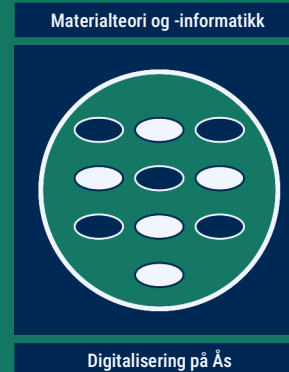

Forskergruppe materialteori og -informatikk

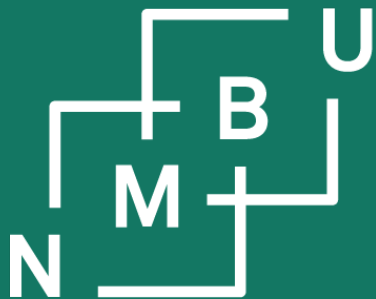

Norges miljø- og
biovitenskapelige
universitet



Moving from FAIR data principles to XAIR

Martin Thomas Horsch
Norwegian University of Life Sciences

CAPE-OPEN Annual Meeting
8th October 2024, Berlin

Fakultet for realfag og teknologi

i.e. "explainable-AI-ready"

Forskergruppe materialteori og -informatikk

The well-known FAIR principles

Findability

- F1. Globally unique **persistent identifiers (PID)**
- F2. **Enriched with metadata**
- F3. Data identifier included in metadata
- F4. Registered in **searchable platform**

Interoperability

- I1. **Formal language** used for **knowledge representation**
- I2. Metadata use **vocabularies** that are themselves FAIR
- I3. Semantic web principles, **data can refer to other data**

Reusability

- R1. Metadata include a plurality of accurate and relevant attributes
 - R1.1. Release data and metadata with an accessible **data usage license**
 - R1.2. Data are annotated with a detailed **provenance description**
 - R1.3. Relevant disciplinary and **community standards** are fulfilled

Accessibility

- A1. **Retrievable from PID** via a standard protocol
 - A1.1. Open and freely implementable protocol
 - A1.2. ... **authentication/authorization** if necessary
- A2. Metadata remain accessible (beyond data)

¹M. D. Wilkinson *et al.*, "The FAIR Guiding Principles ...," doi:10.1038/sdata.2016.18, **2016**.

Opacity vs. transparency

European AI Act: “To address concerns related to opacity and [...] fulfil their obligations under this Regulation, transparency should be required for high-risk AI systems before they are placed on the market [...]. High-risk AI systems should [...] enable deployers to understand how the AI system works [...]. High-risk AI systems should be accompanied by appropriate information”.

Epistemic opacity:

The concept was introduced by **Humphreys** in *Extending Ourselves*¹

¹P. Humphreys, *Extending Ourselves Computational Science, Empiricism, and Scientific Method*, 2004.

Opacity vs. transparency

European AI Act: “To address concerns related to **opacity** and [...] fulfil their obligations under this Regulation, **transparency** should be required for high-risk AI systems before they are placed on the market [...]. **High-risk AI systems** should [...] enable deployers to **understand how the AI system works** [...]. High-risk AI systems should be **accompanied by appropriate information**”.

Epistemic opacity can occur when simulation-based and data-driven methods are used. The concept was introduced by **Humphreys** in *Extending Ourselves*¹ (2004), developed further in later work,² and has had a substantial impact.³

Epistemic opacity (Humphreys, 2011): A «process is **epistemically opaque** relative to a cognitive agent X at time t [... if ...] X does not know at t all of the **epistemically relevant elements**»²

¹P. Humphreys, *Extending Ourselves Computational Science, Empiricism, and Scientific Method*, **2004**.

²P. Humphreys, in M. Carrier, A. Nordmann, *Science in the Context of Application*, pp. 131-142, Springer, **2011**.

³J. M. Durán, N. Formanek, *Minds and Machines* **28**(4): 645-666, doi:10.1007/s11023-018-9481-6, **2018**.

Good practices beyond FAIR

RIOT:¹ Reproducible, Interpretable, Open, Transparent

- Origin: UK Reproducibility Network (UKRN)
- UKRN encouraged foundation of the other reproducibility networks, such as NORRN, the Norwegian Reproducibility Network
- Local “RIOT science clubs” were founded

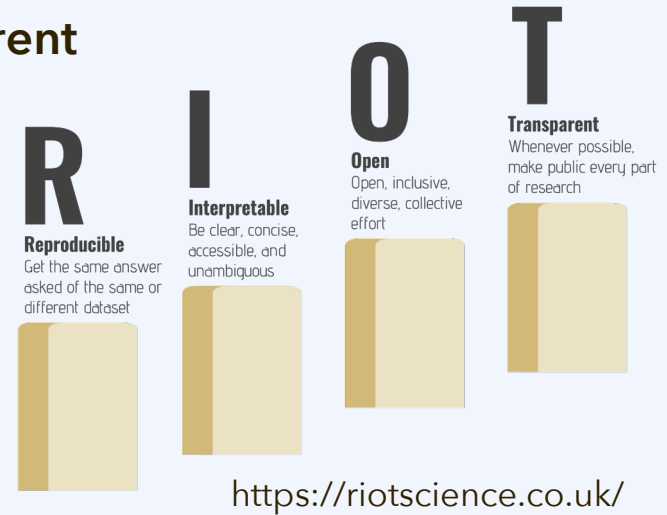

CARE:² Collective benefit, Authority to control, Responsibility, Ethics

- Origin: Global Indigenous Data Alliance
- Uptake supported by the Research Data Alliance
- Orientation: Sovereignty and epistemic justice

<https://www.gida-global.org/care/>



¹E. Ganley *et al.*, *BMC Res. Notes* **15**: 51, doi:10.1186/s13104-022-05932-5, **2022**.

²S. Russo Carroll *et al.*, *Sci. Data* **8**: 108, doi:10.1038/s41597-021-00892-0, **2021**.

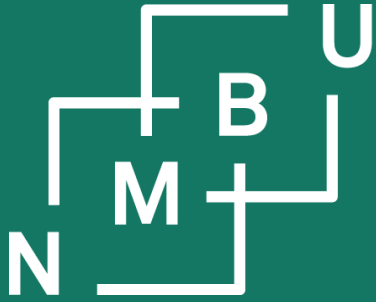

Noregs miljø- og
biovitenskaplege
universitet

The road from FAIR to XAIR (explainable) models, simulations, and data

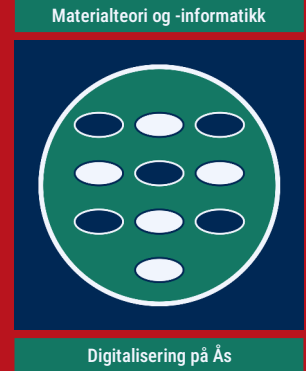



Standardization processes: MODA

CWA 17284:2018 MODA: Model Data

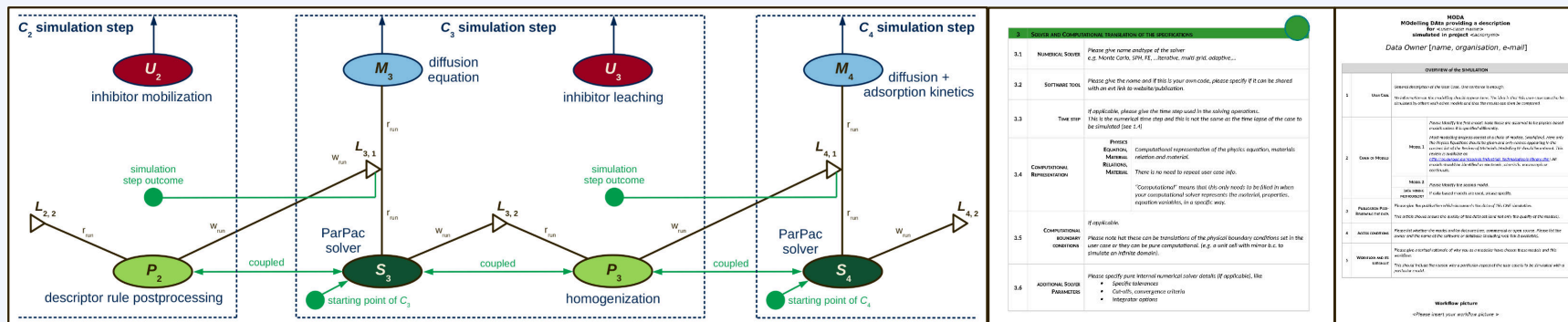

- MODA is a **closed semantic and epistemic space**: Modelling methods have to be chosen from a small list.
- MODA imposes a **given level of detail** in workflow documentation; namely, **unrealistically detailed**.¹
- MODA documentations are **complicated** and **of limited use** to all, including to humans.²

¹J. Chem. Eng Data **65**(3): 1313–1329, doi:10.1021/acs.jced.9b00739, **2020**.

²ReaxPro project deliverable D2.1, «ReaxPro MODA diagrams», **2020**.



CWA 17960 ModGra

The **process model topology** is a generalized Petri net. Tokens represent **extensive physical quantities** or, alternatively, data items that can be exchanged.

The process model's system of equations is represented by the Petri net's **transitions** and the **places** (capacities) which store the balanced quantities, or alternatively the data items.

An **EMMO export**, using **TriG format**, has been developed.

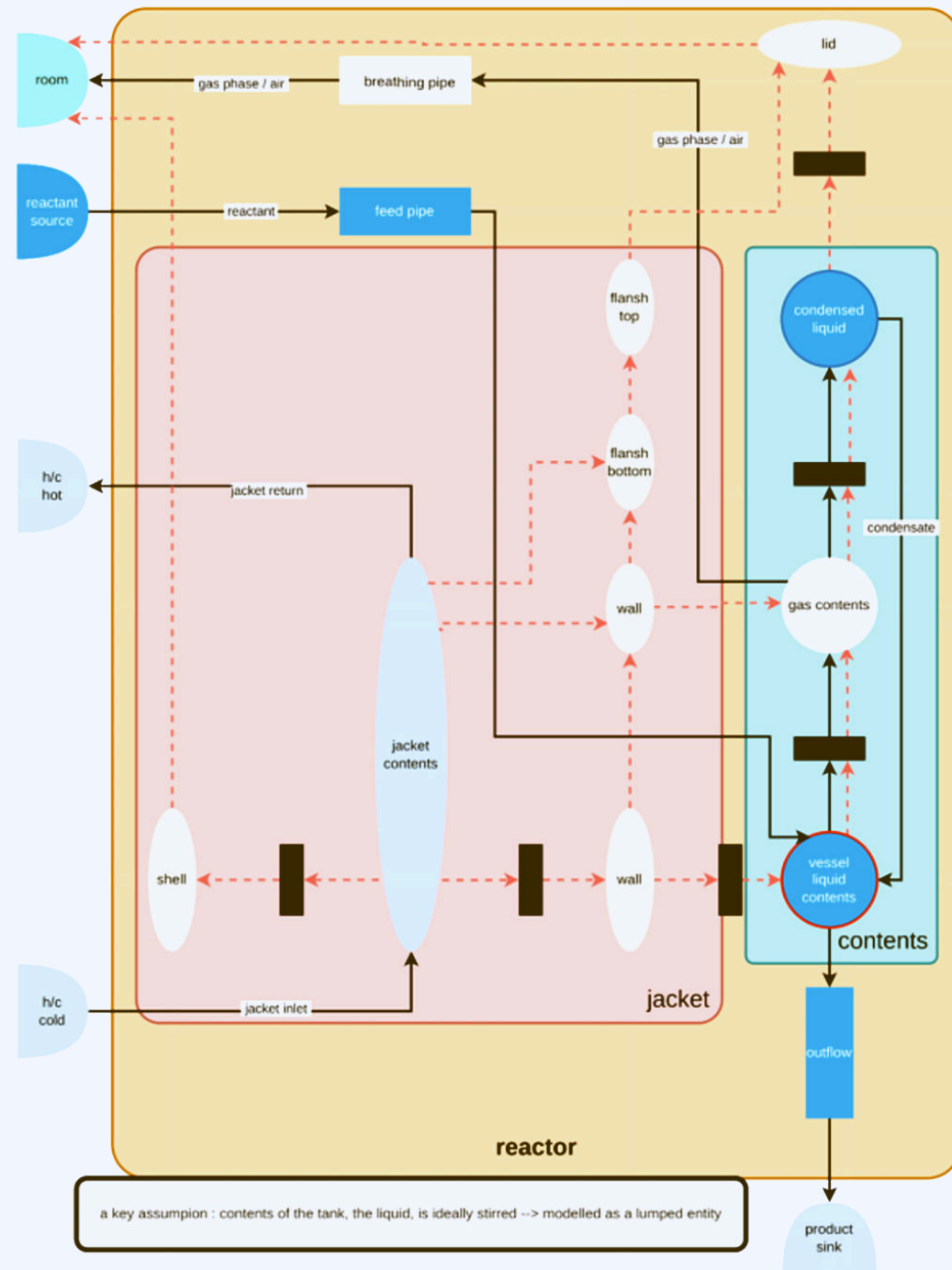

DEXPI and ModGra

- DEXPI and ModGra serve similar purposes. Both are developments from the CAPE community. Both can represent exchange of quantities graphically.
- ModGra is a CEN workshop agreement, while DEXPI is based on existing standards,¹ e.g., DIN 6779-13, ISO 10303, and ISO 10628.

With these assumptions we build the following BFD or top-level model.

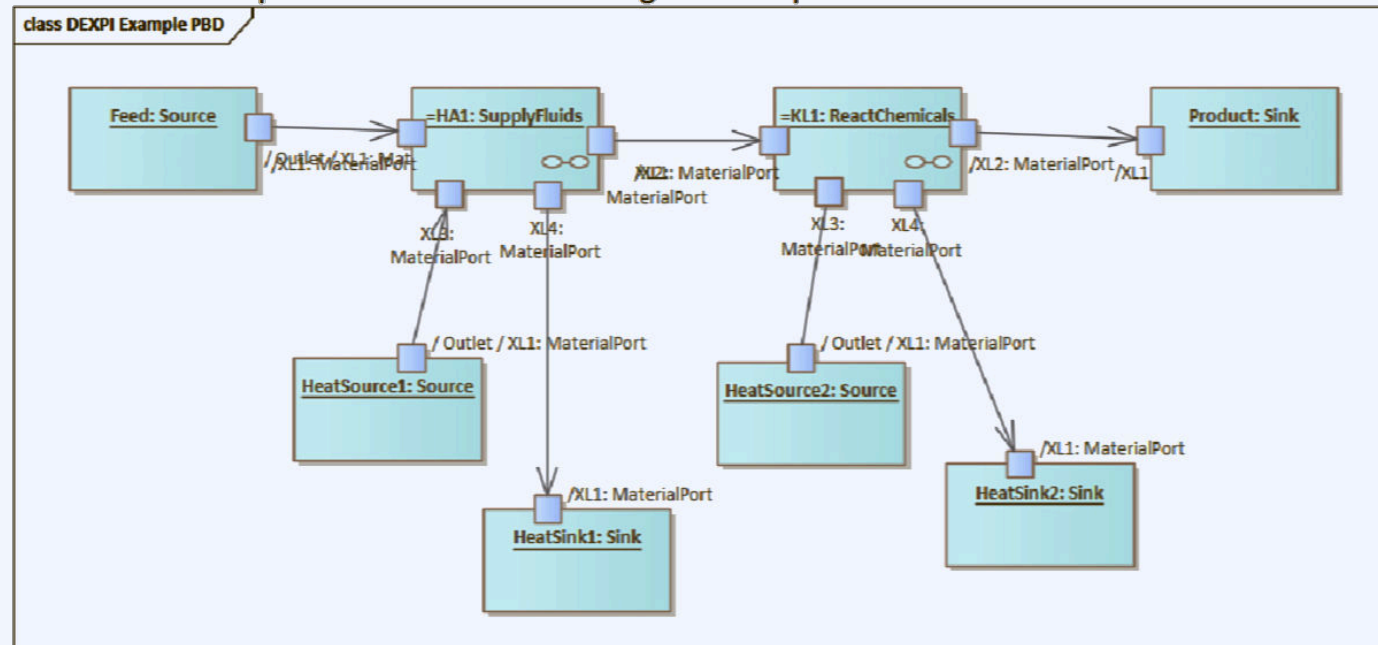

Source for diagram to the left:

¹DEXPI Process Modelling of Process Systems and their Documentation, version 1.0, official release, 2023.

OntoCommons CSA (2020 - 2023)

- **Community development** that brought together applied ontology, industrial digitalization, and computational science and engineering.
- OntoCommons ecosystem¹ (OCES) including the three **foundational ontologies** BFO, DOLCE, and EMMO. Development of **bridge concepts**² as a technique for ontology alignment.

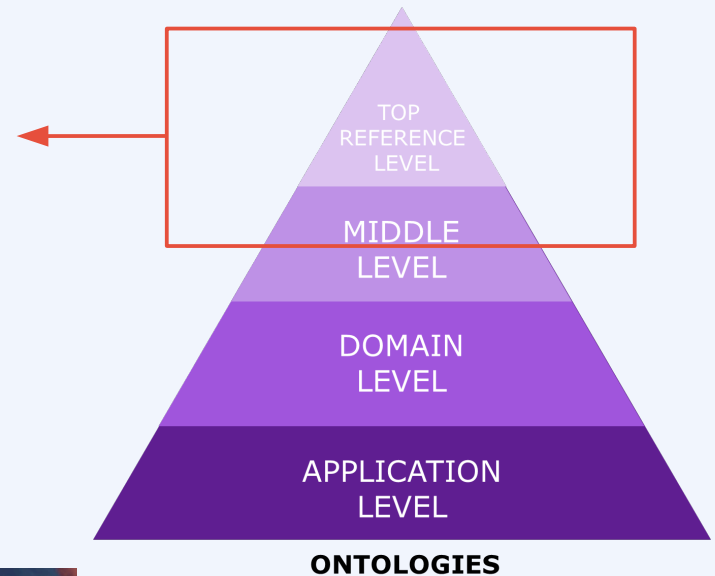

¹M. Magas, D. Kiritsis, *Int. J. Production Res.* **60**(2): 479-492, doi:10.1080/00207543.2021.1989514, **2022**.

²A. de Baas et al., *IEEE Access* **11**: 120372-120401, doi:10.1109/access.2023.3327725, **2023**.

Review of Domain Interoperability¹

OntoCommons CSA collected and supported the design and alignment of **domain-level interoperability standards**. There, CAPE-OPEN and OntoCape were discussed a few times.¹

The overall analysis of modes of interoperability, relevant tools and components, and recommendations was delivered in the form of **RoDI: The Review of Domain Interoperability**.²

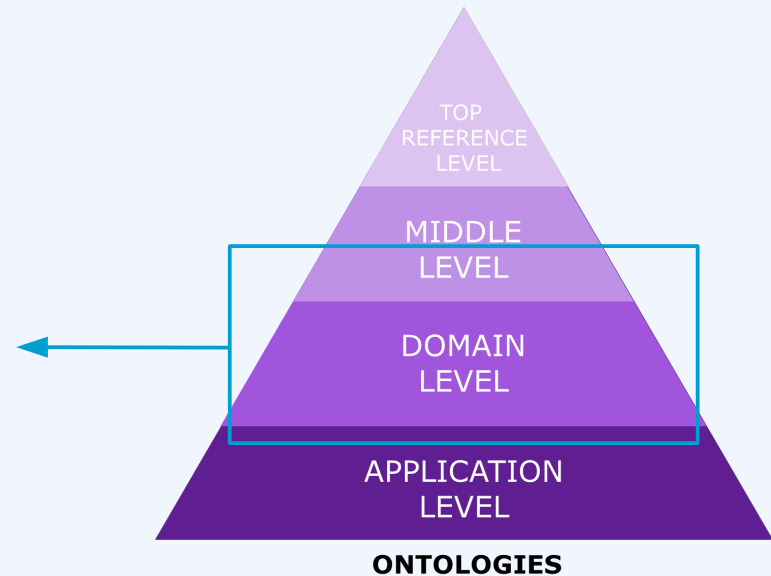

	data	human	organization	software
data (<i>d</i>)	$d \leftrightarrow d$	$d \leftrightarrow h$	$d \leftrightarrow o$	$d \leftrightarrow s$
human (<i>h</i>)	—	$h \leftrightarrow h$	$h \leftrightarrow o$	$h \leftrightarrow s$
organization (<i>o</i>)	—	—	$o \leftrightarrow o$	$o \leftrightarrow s$
software (<i>s</i>)	—	—	—	$s \leftrightarrow s$

Matrix structure for interoperability requirements: Who interoperates with whom?

¹S. Chiacchiera *et al.*, OntoCommons deliverable 3.9, “First focus workshop on domain ontologies,” **2021**.

²S. Chiacchiera *et al.*, OntoCommons deliverable 3.8, “Finalized Review of Domain Interoperability,” **2023**.

“XAIR principles” working group

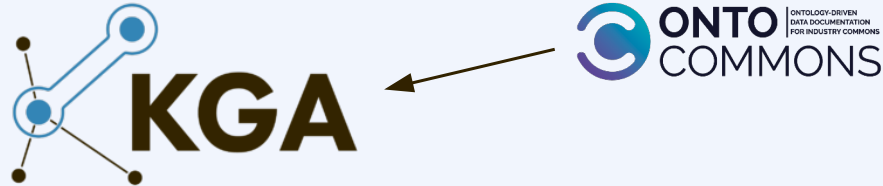

XAI: Explainable artificial intelligence

AIR: Artificial-intelligence ready

XAIR: Explainable AI-ready

Data are **XAIR** to the degree that they are semantically enriched so that **best use** can be made of **interpretable learning** techniques. These include XAI in the narrow sense (learning by induction) and logical reasoning (deduction).

Tendency: **Making data trustworthy through explanations** will increasingly become a requirement. Data must become explainable-AI-ready (XAIR).

Slogan: “FAIR and XAIR data.” (Sounds similar to the idiom “fair and square.”)

"XAIR principles" working group

Months 1 to 10: **Synopsis of literature work on core concepts**

- Identify the core concepts, analyse and summarize the literature characterizing these concepts.
- M10, report, public, "**Synopsis of XAIR core concepts.**"

Months 11 to 16: **Work on actionable core concepts**

- Discussion of use cases; annotation of examples; draft of mid-level and domain ontologies.
- M16, report, public, "Request for comments on actionable XAIR core concepts."

Months 17 to 22: **Work and consultation on XAIR principles**

- Community discussion toward "XAIR principles."
- M22, report, public, "Request for comments on XAIR data and metadata [...] principles [...]".

Months 23 to 34: **Stable release of mid and domain ontologies**

- Ontologies for XAIR are finalized to the extent that no major changes will occur in the future.
- M34, ontologies, public, "[...] Ontologies covering the XAIR key concepts [...]".

Months 35 to 40: **XAIR forward plan and ontology governance**

- Critical analysis of accomplishments and forward-looking discussion.
- M40, report, public, "XAIR forward plan and ontology governance."

DCLXVI 2024 International Workshop

Designing the Conceptual Landscape
for a XAIR Validation Infrastructure

RPTU Kaiserslautern, Germany, 11th December 2024

What information needs to be conveyed to users so that data and models can become **explainable-AI-ready** (XAIR)?

The core concepts for explainable-AI-readiness will be discussed at the **DCLXVI 2024 Workshop** in Kaiserslautern, organized by the Horizon Europe projects AI4Work and BatCAT.

Submit your manuscript by 22nd October 2024. The proceedings will be published in the Springer series Lecture Notes in Networks and Systems.

AI4Work: HEur GA 101135990. BatCAT: HEur GA 101137725.

<https://batcat.info/dclxvi/>



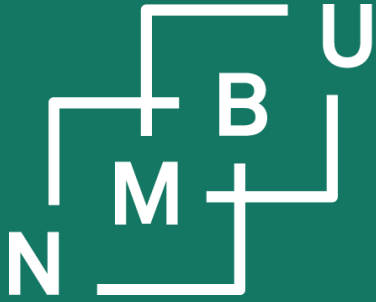

Noregs miljø- og
biovitenskaplege
universitet

Documentation of epistemic metadata

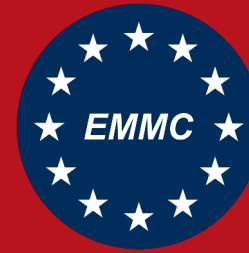

Materialteori og -informatikk

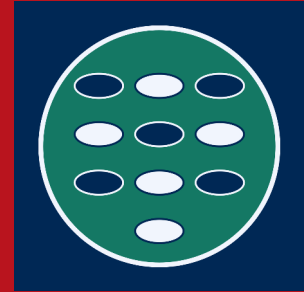

Digitalisering på Ås



EUMINE



Semantic architecture: Epistemic metadata

Epistemic metadata are the information that **establishes the knowledge status** of data or digital objects.¹

Questions we must answer to establish the knowledge status:

- a) “what **knowledge claim** φ has been formulated?,”
- b) “where do the data and the claim come from?” (**provenance**),
- c) “what **validity claim** was made about φ ?,”
- d) “why should we accept any of this?” (**grounding**).

Key epistemic metadata items are the **knowledge claims** made based on data, their **provenance**, **validation** and **reproducibility**, and **epistemic grounding**.

In *Proc. JOWO 2022*, CEUR vol. **3249**: p. 2 (CAOS), CEUR-WS, **2022**.

In *Proc. ICAPAI 2023*, doi:10.1109/icapai58366.2023.10193944, IEEE, **2023**.

In *Proc. FOIS 2023*, pp. 302-319, doi:10.3233/faia231136, IOS, **2023**.

Requirements for epistemic metadata: Case study

Epistemic metadata and their documentation were explored for the domain of molecular modelling and simulation within engineering thermodynamics:

First stage report (10 cases), doi:10.5281/zenodo.7516532, **2023**.

Discussion of *five papers each* from *two research groups* (London, Berlin) without involving the papers' authors. Obtained a tentative **taxonomy for epistemic metadata**, later implemented into the PIMS-II ontology.

Second stage report (12 claims), doi:10.5281/zenodo.7608074, **2023**.

Discussion of *two claims each* from *six papers*, with two papers each from three research groups (London, Berlin, Kaiserslautern), involving the papers' authors. Discussed aspects such as the **grounding of knowledge claims** with authors.

Ontology of epistemic metadata: Knowledge claims

Peircean semiotics is applied to the description of cognitive processes, e.g., consider a process in which dataset δ is analysed, yielding knowledge claim φ :

- The data δ are about some research question q .
So δ is a representamen for q ; it has the role of the **sign**.
- The research question q is the **object** of the semiosis.
- As an outcome of the semiosis, claim φ is obtained, which is a new representamen for q , the **interpretant**.

The part of the PIMS-II ontology that deals with Peircean semiotics is also axiomatized in first-order logic,¹ in addition to the OWL implementation.²



C. S. Peirce

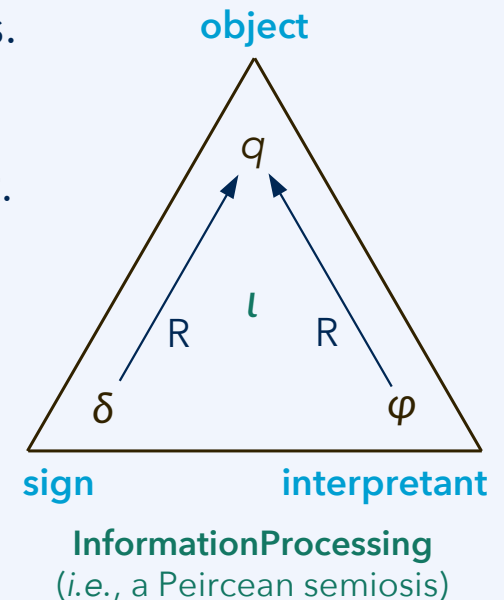

¹«Mereosemiotics: Parts and signs», in *Proc. JOWO 2021 (FOUST)*, 2021.

²OWL implementation under <http://www.molmod.info/semantics/pims-ii.ttl>

Provenance: Documentation with flexible resolution

Peircean semiotics

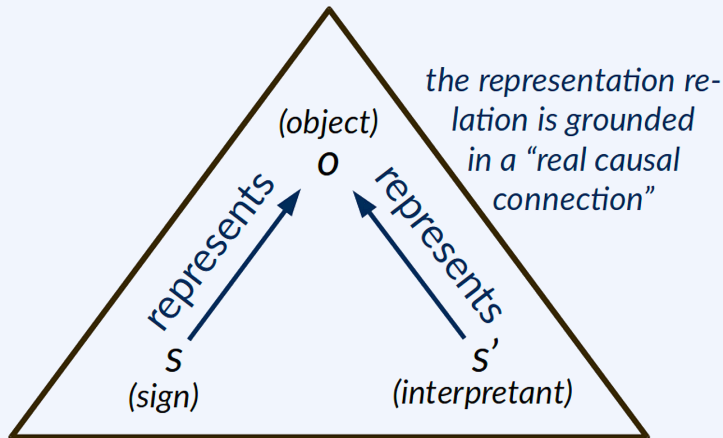

the semiosis, a process by which a new representamen, the interpretant, is created

Cognitive process (example):

- First, experimental data s for material o are used to parameterize a model, obtaining model s' .
- Then, a simulation is done using model s' , yielding the simulation result s'' (which also represents o).

Research workflows as cognitive processes:¹

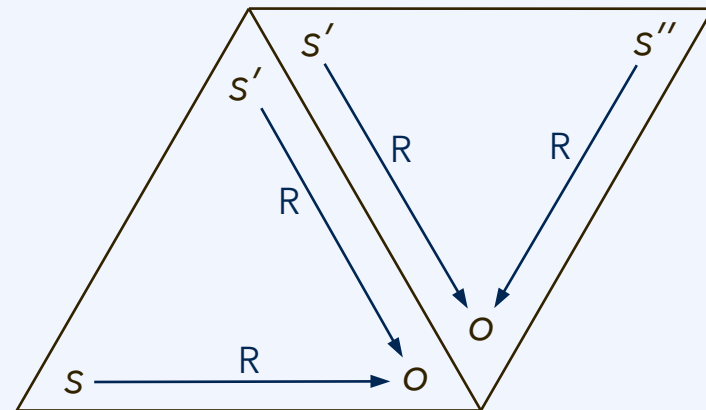

cognitive process K

Each cognitive step starts from one representation relation, e.g., R_{so} , and creates a new one, $R_{s'o}$.

The successor step reuses $R_{s'o}$ and creates the next relation, $R_{s''o}$.

¹In *Proc. JOWO 2021*, CEUR vol. **2969**: p. 3 (FOUST), **2021**.

Validation and falsification



Common formulation and schema for reproducibility claims (RCs):

«Whenever research process κ'' is carried out, it must lead to the outcome φ'' .»

- 1) Researcher a did κ and found φ .
Here, a also made the **positive reproducibility claim** $\psi = \Box(\varphi'' \mid \kappa'')$.
we argue that there is a mechanism from pragmatics at work here
- 2) Researcher b did γ , **consistent with κ''** , and found ζ , **inconsistent with φ''** .
Here, b made the **negative reproducibility claim** $\Diamond(\neg\varphi'' \mid \kappa'') \equiv \neg\Box(\varphi'' \mid \kappa'') \equiv \neg\psi$.
- 3) What is relevant there is the **contradiction between ψ and $\neg\psi$** .

provenance metadata κ
provenance paradata κ'

provenance orthodata $\kappa'' = \kappa - \kappa'$

«repeat κ , but no need to retain κ' »

knowledge claim metadata φ
knowledge claim paradata φ'

knowledge claim orthodata $\varphi'' = \varphi - \varphi'$

«obtain φ again, except for φ' maybe»

Epistemic grounding

See also the reference ontology of trust **ONTrust** by Baratella *et al.*^{1,2}

	trust	reliance
Type-1 The results establish their own validity.	<i>Typical:</i> Mathematical argument (proof) over of a conceptual framework designed around widely accepted definitions and axioms .	<i>Schema:</i> A new theory is more reliable because it is simpler , covers more phenomena , or represents underlying physics. (theoretical virtues)
Type-2 The provenance of the results tells that they are valid.	<i>Case study example:</i> Chatwell and Vrabec argue: It is OK to use a cutoff radius of 5.5σ for the LJ potential, since this was done in three cited works from the literature .	<i>Typical:</i> We used a model, method, and simulation code validated in the past and - usually - very accurate. (process reliabilism)

¹Baratella *et al.*, «The many facets of trust», in *Proc. FOIS 2023*, doi:10.3233/faia231115, **2024**.

²<https://github.com/unibz-core/trust-ontology>

Mid-level ontology of epistemic metadata

PIMS-II is an **ontology of cognitive processes**,¹ including epistemic metadata

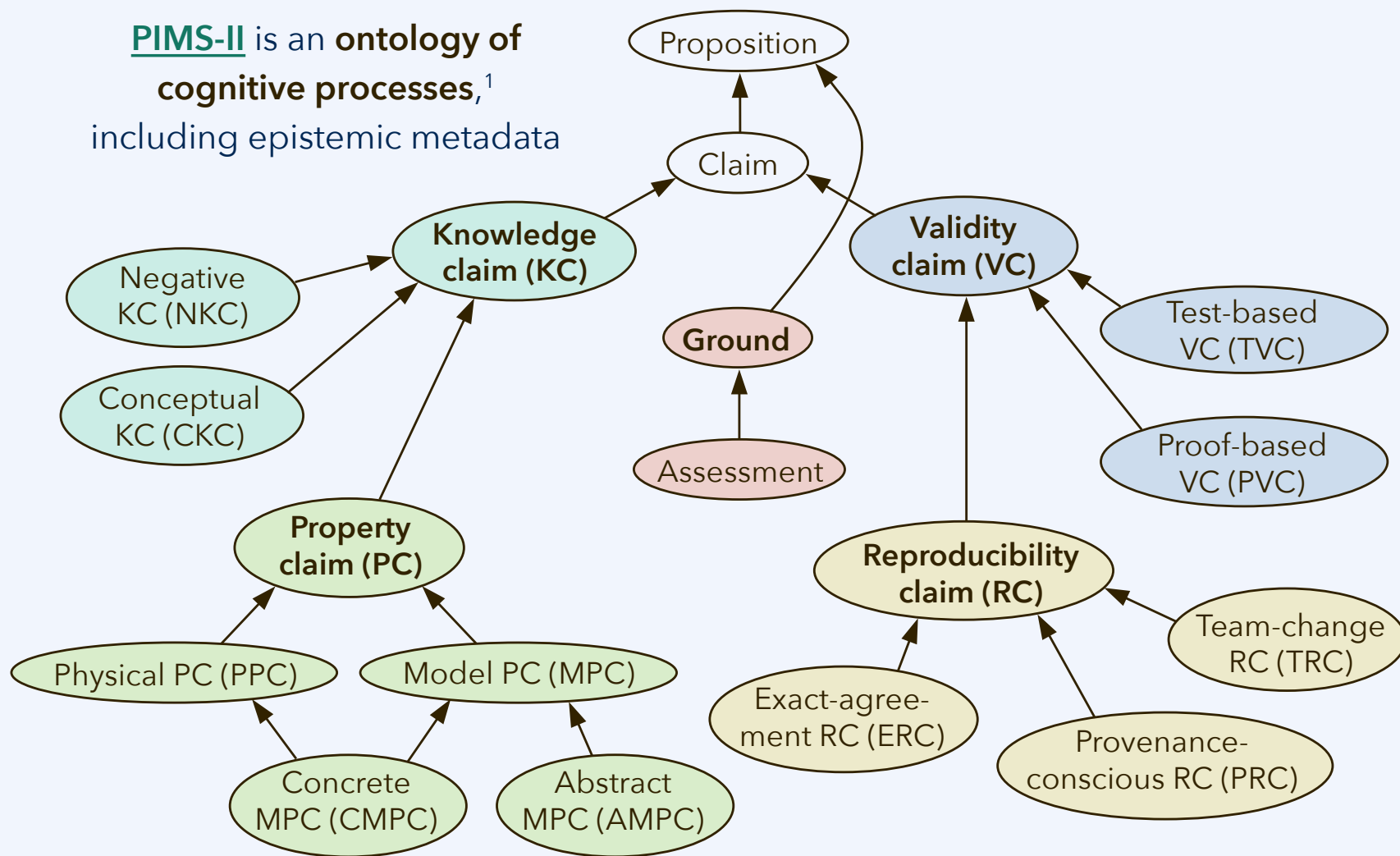

¹OWL implementation under <http://www.molmod.info/semantics/pims-ii.ttl>

Mid-level ontology of epistemic metadata

In PIMS-II, scientific workflows are described in terms of cognitive processes.¹⁻³

perception requires the presence of the perceived object

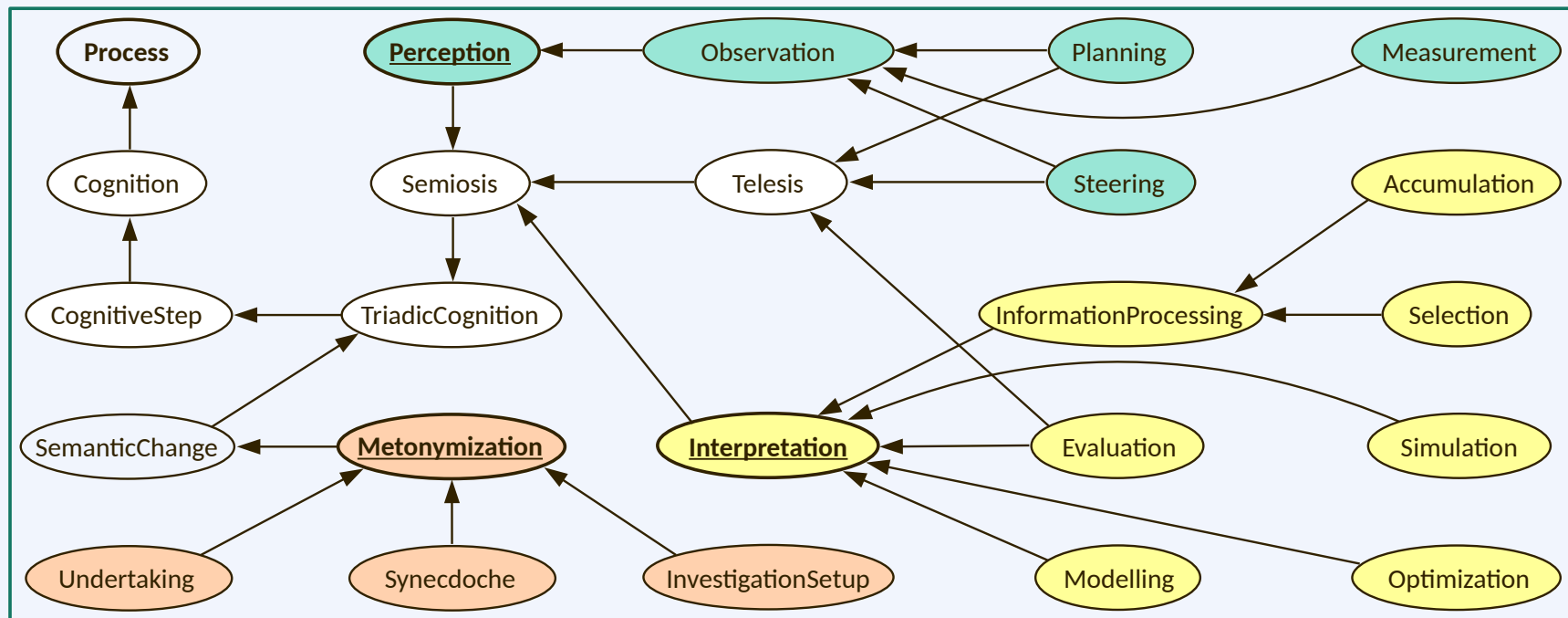

metonymization preserves the „real causal connection“ (Peirce) between the sign and its old & new referents

interpretation and **metonymization** do not require physical presence of the referents

¹M. T. Horsch, no. 3 in *Proc. JOWO 2021*, 2021.

²P. Klein et al., no. 26 in *Proc. JOWO 2021*, 2021.

³OWL implementation under <http://www.molmod.info/semantics/pims-ii.ttl>

Mid-level ontology refactoring



PURL for the new system, MSO-EM (ontologies for **modelling, simulation, optimization**, and **epistemic metadata**), which is under construction:

<https://www.purl.org/mso-em>

BatCAT organizational github: <https://github.com/HE-BatCAT>

Design principles:

- Strong alignment with DOLCE (through DOLCE Lite)
- OWL2 EL profile expressivity level
- Ongoing development, with easy stable access to versioned releases
- Simple modules, each with maximum three taxonomy levels and maximum three top concepts
- Backwards compatibility with equivalences to the preceding mid-level ontology development (PIMS-II) to the maximum possible extent

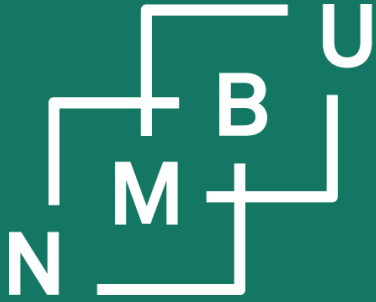

Noregs miljø- og
biovitenskaplege
universitet

DigiPass CSA: Developing the digital materials and product passport

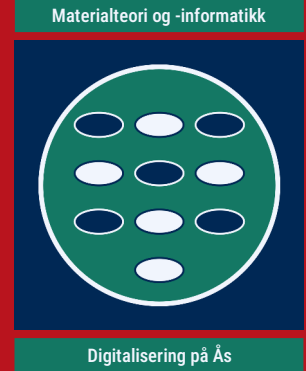

DigiPass CSA

- O1 Enhance communication and cooperation among diverse communities.
- O2 Promoting the exchange of materials data and knowledge
- O3 Creation and utilization of Digital Product Passports
- O4 Demonstrate the projects developments and coordination actions
- O5 Establish collaborative digital skills training schemes
- O6 Elaborate the Business Plan



DigiPass CSA

Four demonstrators:

Case 1: 
Advanced composites

Case 2: 
Advanced materials for
renewable energy sources

Case 3: 
Health and safety when
using nanomaterials

Case 4: 
Pre-painted metals

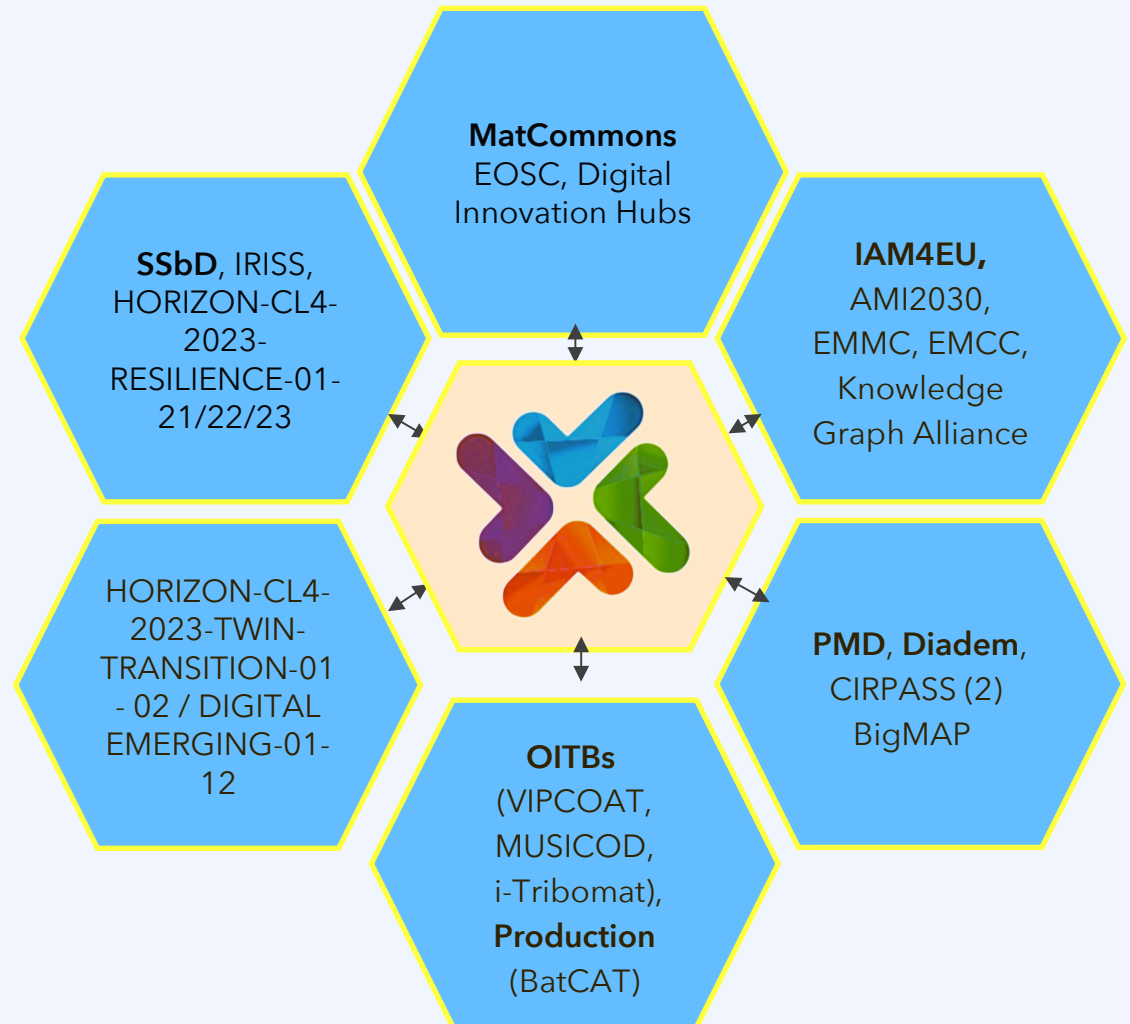

DigiPass CSA



WP7: Semantic interoperability and data spaces



Fraunhofer

ITWM

WP2: Digital materials and product passport



WP10: Sustainability and business plan



WP6: Metadata standardization



WP3: Data acquisition and knowledge generation



WP4: Best practices



WP8: DigiPass ecosystem
WP9: Collaboration, dissemination, training



WP1: Materials data and information systems



Demonstration case: Pre-painted metals supply chain



WP5: Innovation process

Demonstration case: Advanced materials for renewable energy sources



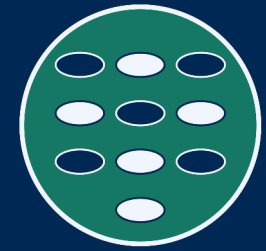
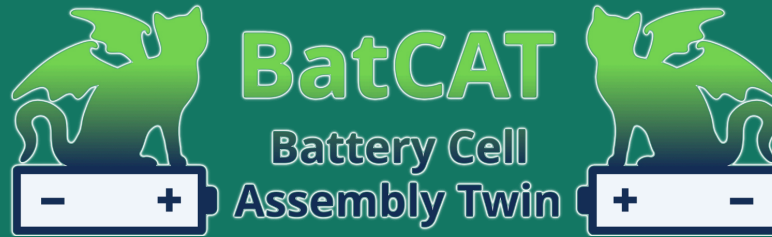
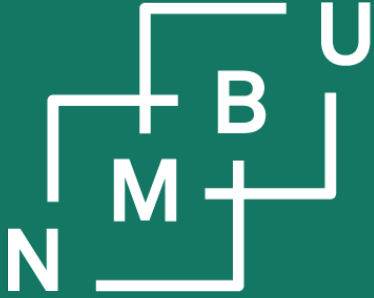

BatCAT has received funding from the European Union's **Horizon Europe** research and innovation programme under **grant agreement no. 101137725**. Views and opinions expressed are however those of the author only and do not necessarily reflect those of the project, the European Climate, Infrastructure and Environment Executive Agency (CINEA), or the European Union. Neither BatCAT nor the CINEA or the EU can be held responsible for them.



**Finansiert av
Den europeiske union**

8th October 2024

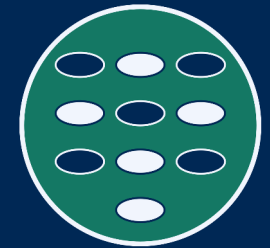
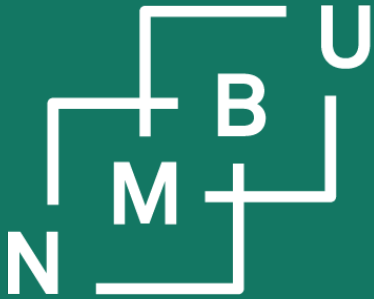

DigiPass CSA has received funding from the European Union's Horizon Europe research and innovation programme under **grant agreement no. 101138510**. Views and opinions expressed are however those of the author only and do not necessarily reflect those of the project, the European Health and Digital Executive Agency (EHDEA), or the European Union. Neither DigiPass CSA nor the EHDEA or the EU can be held responsible for them.



**Finansiert av
Den europeiske union**

8th October 2024

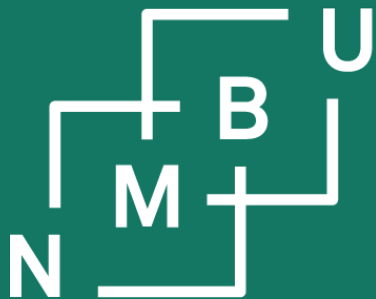

Norges miljø- og
biovitenskapelige
universitet

Moving from FAIR data principles to XAIR

Martin Thomas Horsch
Norwegian University of Life Sciences

CAPE-OPEN Annual Meeting
8th October 2024, Berlin

Fakultet for realfag og teknologi

Forskergruppe materialteori og -informatikk

